



PHOTO COURTESY OF FINIS, INC.

WONDER AT WINTER SAVINGS!

EFFECTIVE: JANUARY 1 - APRIL 30, 2025



COMPETITOR PACE CLOCKS

Item #	Description	Price
58-002	37" Battery-Powered Pace Clock	\$642.50
58-010	31" Battery-Powered Pace Clock	\$402.75
58-015	Portable Roll-Away Stand	\$154.50
58-045	15" Portable Pace Clock	\$228.50

Replacement parts are available. Contact us for details.



58-002

37" DIAMETER

- Battery-powered clock
- White body with a white face or a black face
- Includes retractable stabilizing plate

31" DIAMETER

- Battery-powered clock
- White body with a white face or a black face
- Optional roll-away stand ordered separately

15" DIAMETER

- Battery-powered clock
- White or red clock body with a white face or a black face



62-085

62-086

EQUIPMENT TOTEMASTERS

- Lockable lid to secure your facility supplies
- **Equipment Totemaster** - single lid style
Size: 3½' W × 2' L × 3' H
- **Totemaster Plus**- dual lid with internal divider
Size: 5' W × 2' L × 3' H

Item #	Description	Price
62-085	Equipment Totemaster	\$250.00
62-086	Totemaster Plus	\$350.00



59-110

INFINITY STARTING SYSTEM BY COLORADO TIME SYSTEMS WHILE SUPPLIES LAST!

- Highly visible strobe light
- Harmonic starting horn sound
- Includes: wired microphone and internal gel-cell battery (tripod ordered separately)

Item #	Description	Price
59-110	Infinity Start System w/ Wired Microphone	\$975.00
59-115	Infinity Start System Tripod	\$215.00



50-160

50-170

LANE LINE PARTS

Item #	Description	Price
50-160	Competitor Ratchet Take-Up Reel	\$92.50
50-170	Competitor Ratchet Wrench	\$29.50
50-220	Anti-Wave Supertensioner*	\$98.75

*Specify color: maroon, red, orange, yellow, green, teal, light blue, blue, dark blue, purple, white, silver, gray, or black

PARAGON STARTING PLATFORMS

- The platform of choice across the country
- Stainless steel pedestals with polypropylene top
- 24" x 32" Track Start platform top size
- Includes- horizontal backstroke bars & standard white color top and step
- Meets & exceeds all ruling body standards
- Specify lane numbers when ordering
- Side Hand Grips & Track Start Plus Back Plate Kit – ordered separately
- Optional custom colors, logos, & powder coating also available

COMPETITOR TRACK START

Item #	Description	Price
52-010	Side-Mount	\$3904.50
52-030	Rear-Mount	\$5065.50
52-156	Competitor Dual-Leg Anchor	\$452.50

TRACK START QUICKSET

Item #	Description	Price
52-032	Side-Mount	\$3552.50
52-031	Rear-Mount	\$3552.50
52-115	Quickset Platform Anchor	\$452.50
52-250	Track Start+ Back Plate Kit	\$855.25
52-255	Track Start+ Side Hand Grip Kit*	\$255.20

*Set of two



TRACK START QUICKSET SIDE-MOUNT PLATFORM (SHOWN WITH OPTIONS)



COMPETITOR TRACK START SIDE-MOUNT PLATFORM



COMPETITOR TRACK START REAR-MOUNT PLATFORM



TRACK START QUICKSET REAR-MOUNT PLATFORM



52-340

SR SMITH VELOCITY SINGLE POST STARTING PLATFORMS

- Side-mount platform with fiberglass footboard and TrueTread or SandTread slip resistant surface
- 28" x 32" top size
- 5-position Track Start Wedge tucks under platform top when not in use
- Colorado and Daktronics timing systems compatible
- Includes- RockSolid anchor and 4- backstroke handle options
- Optional side handles also available
- Custom color treads and team logos available on sand tread footboard models

Item #	Description	Price
52-340	Velocity Side-Mount Platform with TrueTread	\$4152.75
52-345	Velocity Side-Mount Platform with SandTread	\$3796.50
52-350	Velocity Side-Mount Long Reach Platform w/ TrueTread	\$5134.50
52-355	Velocity Side-Mount Long Reach Platform w/ SandTread	\$4763.40
63-375	RockSolid Anchor	\$670.75



53-020

CHAMPION™ BACKSTROKE PENNANTS

- Heavy duty 12 oz. vinyl pennants
- Triangular pennant size: 12" x 18"
- Install flags onto 3/16" vinyl covered stainless steel cable
- Flags, cable & hardware package ordered separately
- Colors: navy blue, royal blue, medium blue, white, red, green, yellow, orange, purple, light gray, black, brown, & maroon

Item #	Description	Price
53-020	Backstroke Pennants (each)	\$5.53
50-175	3/16" Vinyl-Covered Cable (per foot)	\$1.20
53-030	Hardware Package (each)	\$132.50
53-040	EZ Hardware package (each)	\$160.75

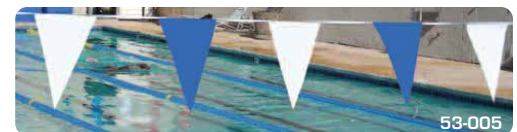

53-005

BACKSTROKE PENNANTS

- 12" W x 18" L vinyl pennants on canvas header
- Alternating colors: red/white, blue/white, or green/white

Item #	Description	Price
53-006	50' Backstroke Pennant Line	\$112.25
53-007	60' Backstroke Pennant Line	\$134.75
53-008	75' Backstroke Pennant Line	\$159.50



50-155

NEW! COMPETITOR EZ-TENSIONER

- Easily tighten your lane line in 3 clicks
- One motion to release the tension
- No wrench needed
- Includes neoprene cover
- Can be ordered as retrofit to any lane line or an upgrade on new lane line purchase

Item #	Description	Price
50-155	Competitor EZ-Tensioner	\$125.50
50-156	EZ-Tensioner Upgrade, per Lane	\$38.50

COMPETITOR LANE LINES

- Available in 2 sizes: 4" Competitor and 6" Gold Medal
- Official Lane Line of USA Swimming and NCAA
- Lanes come fully assembled
- Longest lasting Lane Line with LifeSpan+ additive
- Disc and donut colors: Any combination of red, white, blue, sky blue, navy blue, green, yellow, black, maroon, orange, Vegas gold, gray, or purple
- All Competitor lane lines can be ordered with the new EZ-Tensioner as an upgrade, one per lane

COMPETITOR 4" DIAMETER RACING LANES

Item #	Length	Price
50-029	60'	\$429.50
50-030	75'	\$462.50
50-035	25M	\$492.50
50-040	50M	\$922.00
50-075	25M w/ Removable Piece to Convert to 1-75' Lane	\$628.25
50-080	50M w/ Removable Piece to Convert to 2-75' Lanes	\$1104.25

COMPETITOR GOLD MEDAL 6" RACING LANES

Item #	Length	Price
50-004	60'	\$495.25
50-005	75'	\$564.50
50-010	25M	\$594.50
50-015	50M	\$1120.12
50-060	25M w/ Removable Piece to Convert to 1-75' Lane	\$742.50
50-065	50M w/ Removable Piece to Convert to 2-75' Lanes	\$1339.00



51-025

ELITE STOR-LANE REEL

- Powder coated aluminum w/ enclosed reel discs
- Includes transport handle
- 6" locking casters
- Optional custom colors/logos
- Holds 902' of 4" lanes 492' of 6" lanes

Item #	Description	Price
51-025	Elite Stor-Lane Reel	\$3099.00
51-026	Elite Reel Cover	\$219.50



51-005



51-010

CLASSIC STOR-LANE REEL

- Powder coated aluminum frame with PVC reel discs
- Transport handle
- 5" locking stainless casters
- Holds 525' of 4" lanes or 300' of 6" lanes

Item #	Description	Price
51-005	Classic Stor-Lane Reel	\$1665.55
51-010	Classic Reel Cover	\$145.75



51-006

COMPETITOR CLASSIC PLUS REEL

- Powder coated aluminum frame and reel discs
- Newly re-designed with transport handle
- 5" locking stainless casters
- Holds 525' of 4" lanes or 300' of 6" lanes

Item #	Description	Price
51-006	Classic Plus Stor-Lane Reel	\$2180.00
51-010	Classic Reel Cover	\$145.75



51-036

PARAGON STORAGE REELS

- Stainless steel lane storage reel
- Available with zinc or stainless steel locking casters
- Lane Storage Reel holds 540' of 4" (300' of 6" lanes)
- Large Storage Reel holds 720' of 4" (400' of 6" lanes)

Item #	Description	Casters	Price
51-036	Lane Storage Reel	Zinc	\$2719.50
51-037	Lane Storage Reel	Stainless	\$3172.00
51-038	Large Storage Reel	Zinc	\$2945.00
51-039	Large Storage Reel	Stainless	\$3398.00



54-002

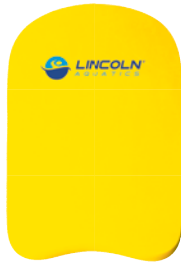

54-004

CHAMPION KICKBOARDS

- Sturdy EVA foam construction
- Standard Kickboard - 18" L x 11 1/2" W - Blue
- Junior Kickboard - 14" L x 10" W - Yellow

Item #	Description	Color	Price
54-002	Standard Kickboard	Blue	\$15.25
54-004	Junior Kickboard	Yellow	\$10.25



54-043

CHAMPION PULL BUOY

- Sturdy EVA foam construction
- Standard Pull Buoy- 9 3/8" L - Blue/White
- Junior Pull Buoy- 8 1/4" L - Blue/Yellow

Item #	Description	Price
54-043	Standard Pull Buoy	\$11.50
54-044	Junior Pull Buoy	\$8.50



TYR® CROSSBLADE 2.0

- Rubber training fins with thickened foot pocket
- Color coded fin blades by size
- Sizes: XXS, XS, S, M, L, XL, or XXL

Item #	Description	Price
55-110	TYR® Crossblade Fins 2.0	\$38.75



TYR® FLEXFINS 2.0

- Rubber training fins
- Color coded fin blades by size
- Sizes: XXXS, XXS, XS, S, M, L, XL, or XXL

Item #	Description	Price
55-100	TYR® Flexfins 2.0	\$35.50



TYR® CATALYST TRAINING PADDLES

WHILE SUPPLIES LAST!

- Builds strength and develops stroke technique
- Sizes: XXS, XS, S, M, L, XL, or XXL

Item #	Description	Price
54-100	TYR® Catalyst Training Paddles	\$11.50



54-105

BADU SWIM MIRROR

- 24" x 32" polished stainless steel w/ PVC backing
- Helps swimmer stay in unmarked "swim lane"
- Portable

Item #	Description	Price
54-105	BADU Swim Mirror	\$275.00



56-051

SWIM TRAINING PLATFORM

- 300 lb (136 kg) weight limit
- 36" x 60" (91 cm x 152 cm) fade resistant polypropylene deck
- Multi-use – swim training, additional seating, rehab and more
- Skid-resistant and barefoot friendly
- Adjustable height 16 1/2" - 22 1/2" (42 cm - 57 cm)
- Limited One Year Warranty
- Made in the USA

Item #	Description	Price
56-051	Swim Training Platform	\$1068.95



SWIM TRAINER

- Great for swim lessons or water exercise classes
- 30" PVC bar with 7" diameter floats

Item #	Description	Price
56-065	Swim Trainer	\$29.50

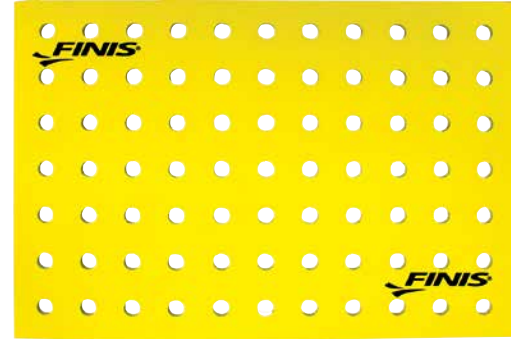

63-082

FINIS® FLOATING ISLAND

- Builds swimming confidence
- Flexible EVA foam
- Fun learn-to-swim tool
- Size: 50" W x 35" H x 1" Thickness

Item #	Description	Price
63-082	Floating Island	\$104.00



Aqua Creek Products
Leading in Recreation, Fitness and Ability



02-050



02-155

ALGIMYCIN 2000

- Kills green, black, and mustard algae
- Prevents new growth and will not stain
- Initial treatment: 8 oz. per 10,000 gallons
- Visible algae growth: 16-24 oz. per 10,000 gallons
- Weekly maintenance: 4-8 oz. per 10,000 gallons

Item #	Description	Size	Price
02-050	Algimycin 2000	Quart	\$29.50

SEAKLEAR CHITOSAN CLARIFIER

- Clarifies cloudy water
- Removes excess oils and lotions
- Dosage: 1 oz. per 10,000 gallons

Item #	Description	Size	Price
02-145	Chitosan Clarifier	Quart	\$19.25
02-155	Chitosan Clarifier	Gallon	\$59.25



03-320



03-212



03-100

CV-600 ENZYME WATER CLEANER

- 100% Natural formula
- Effectively digests organic contaminants
- NSF Listed

Item #	Description	Size	Price
03-320	Enzyme Water Cleaner	Quart	\$28.50
03-321	Enzyme Water Cleaner	Gallon	\$89.75
03-322	Enzyme Water Cleaner	5 Gal	\$309.25
03-323	Enzyme Water Cleaner	15 Gal	\$735.50
03-324	Enzyme Water Cleaner	55 Gal	\$2079.50

SELF-FLOCCING DEFOAMER

- Defoamer and Chitosan polymer flocculant

Item #	Description	Size	Price
03-212	Self-Floccing Defoamer	Quart	\$23.75

THICK TILE AND VINYL CLEANER

- Thick formula clings to tile while cleaning

Item #	Description	Size	Price
03-100	Tile & Vinyl Cleaner	Quart	\$12.50



02-136



02-137

PHOSPHATE REMOVER CONCENTRATE

- Highly concentrated formula removes phosphates
- NSF Listed

Item #	Description	Size	Price
02-136	Phosphate Remover	Quart	\$40.75
02-137	Phosphate Remover	Gallon	\$109.50
02-138	Phosphate Remover	5 Gal	\$485.25



02-102

OXY SPLASH

- Enhanced non-chlorine shock
- Compatible with all other winterizing chemicals
- Use of an algicide is recommended in addition when winterizing

Item #	Description	Size	Price
02-101	Oxy Splash	2 lb	\$22.95
02-102	Oxy Splash	6 lb	\$54.75
02-103	Oxy Splash	25 lb	\$189.25



03-240

CLEAN AND PERFECT

- Citrus based enzyme cleaner breaks down oil and grease
- Use on tile, decks, and patio furniture
- 100% biodegradable

Item #	Description	Size	Price
03-240	Clean & Perfect	22 oz	\$12.50



02-140

PRO SERIES STAIN AND SCALE CONTROL

- Protects pool from metal staining and scale buildup
- Initial dosage: 32 oz. per 10,000 gallons
- Monthly dosage: 5 oz. per 10,000 gallons

Item #	Description	Size	Price
02-140	Stain & Scale Control	Gallon	\$57.25



01-448

SODIUM THIOSULFATE

- Reduces high concentrations of Chlorine or Bromine
- 1 oz. will neutralize 1 PPM Chlorine/Bromine per 10,000 gallons

Item #	Description	Size	Price
01-448	Sodium Thiosulfate	1 lb	\$9.75



03-105



03-480

ENZYMepro COMMERCIAL

- Breaks down organic contaminants
- Initial dosage: 1 gallon per 50,000 gallons
- Weekly maintenance dosage: 1 quart per 50,000 gallons

Item #	Description	Size	Price
03-105	ENZymePro Commercial	5 Gal	\$279.00

REVIVEPRO COMMERCIAL

- Remove phosphates, metals, scaling carbonates, and other organics
- Formulated for refills, start-ups, and routine maintenance

Item #	Description	Size	Price
03-480	RevivePro Commercial	5 Gal	\$523.00
03-485	RevivePro Commercial	30 Gal	\$2449.00



10-145

STENNER S SERIES S50

- 3.2 to 315 GPD
- 20 volt, 25 psi
- OLED Operating Display
- NEMA 4X
- NSF 50 Listed

Item #	Description	Price
10-145	Stenner S50 Pump, 315 GPD	\$1675.80



10-155

STENNER S VARIABLE SERIES

- 7.5 to 150 GPD
- 120 volt, 25 psi
- Potentiometer and LED indicators
- NEMA 4X
- NSF 50 Listed

Item #	Description	Price
10-155	Stenner S4V5 Pump, 150 GPD	\$995.30



10-096

STENNER CLASSIC SERIES

- Self-priming, peristaltic feed pump
- Manually adjustable flow rate output
- 120 volt, 25 psi
- NSF 50 Listed

Item #	Description	Price
10-096	Stenner 45M Pump, 50 GPD	\$464.80
10-101	Stenner 85M Pump, 85 GPD	\$464.80



23-035

TAYLOR TEST KITS

- DPD Drop Test or FAS-DPD Titration
- Available with .75 oz. or 2 oz. reagents

Item #	Description	Reagent Size	Price
23-035	DPD Drop Test	.75 oz	\$64.50
23-040	DPD Drop Test	2 oz	\$115.00
23-041	FAS-DPD Titration	.75 oz	\$79.55
23-043	FAS-DPD Titration	2 oz	\$139.50



24-001

WATERLINK SPINTOUCH KIT

- Digital photometer with touchscreen readout
- Simultaneously test 10 parameters
- Precise repeatable results in 60 seconds
- SpinTouch reagent discs ordered separately
- NSF Listed

Item #	Description	Price
24-001	SpinTouch w/ Carrying Case	\$1195.00



23-136

PALINTEST LUMISO POOLTEST PHOTOMETERS

- Pooltest 3 – tests chlorine, pH, and cyanuric acid
- Pooltest 6 – adds bromine, calcium hardness, and alkalinity tests
- Pooltest Expert – All-around testing with 35+ tests and a large touchscreen
- Kits include recycled material carrying case

Item #	Description	Price
23-136	Lumiso Pooltest 3	\$662.50
23-121	Lumiso Pooltest 6	\$842.50
23-119	Lumiso Pooltest Expert	\$1955.25



05-030

CHEMTROL PC 1500

- ORP and pH control
- Temperature and Langelier Index monitoring
- Includes flow cell assembly and paddle wheel flow switch
- 5 Year Electronics Warranty

Item #	Description	Price
05-030	Chemtrol PC 1500	\$3489.25



05-036

CHEMTROL PC 2100

- ORP and pH control
- Includes flow cell assembly and paddle wheel flow switch
- Factory start-up required
- 5 Year Electronics Warranty

Item #	Description	Price
05-036	Chemtrol PC 2100	\$3700.00
05-136	Factory Start-Up (required)	\$1650.00



08-107

08-110

CCH® ELITE CHLORINATION SYSTEM

- High capacity erosion (HCE) feeders for any commercial application
- CCH Elite 30 – up to 36 PPD
- CCH Elite – up to 127 PPD
- NSF Listed

Item #	Description	Price
08-107	CCH Elite 30 Feeder w/ ORP	\$985.75
08-110	CCH Elite Feeder	\$5545.50



81-935

AQUA CREEK MIGHTY SERIES POOL LIFTS

- Powder-coated stainless-steel construction
- Lift rotates 360 degrees in either direction
- Includes: battery, charger, & handheld controller
- Installs with setback of 10"- 44", with adjustable height seat pole
- ADA Compliant & UL Certified

Item #	Description	Weight Capacity	Price
81-935	Mighty 400 Lift	400 lbs	\$7157.25
81-940	Mighty 600 Lift	600 lbs	\$8216.75



81-864

AQUA CREEK SCOUT EXCEL POOL LIFT

- ADA Compliant & UL Safety Certified
- 375 lb (170 kg) weight limit
- 360° direct drive rotation
- Clearance up to 27" (68 cm)
- Maximum setback 44" (111 cm)
- Great for in-ground and partially raised pools and spas
- Adjustable seat height & footrest
- Stainless steel with durable powder coat finish
- Includes 24v rechargeable battery and charger
- Solar options available
- Color options available
- Limited Five Year Warranty
- Made in the USA

Item #	Description	Weight Capacity	Price
81-864	Scout Excel Pool Lift	375 lbs	\$7157.25



81-819

MULTILIFT2 AQUATIC LIFT

- Field-reversible seat
- Powder-coated stainless steel and aluminum construction
- LiftOperator Intelligent Controller California CEC compliant
- ADA Compliant
- Inquire for anchoring options
- Colors: Grey Mist, Slate, or Taupe

Item #	Description	Weight Capacity	Price
81-819	multiLift2 less anchor	350 lbs	\$4640.75



81-740

PAL2 PORTABLE AQUATIC LIFT

- Portable lift with remote and 240° rotation
- Powder-coated stainless steel and aluminum construction
- Includes: battery w/ console cover, charger, footrest, and seat belt
- ADA Compliant

Item #	Description	Weight Capacity	Price
81-740	Pal2 Portable Lift	300 lbs	\$8695.00



81-740



81-625

PROFORMANCE AQUATIC LIFT

- Powder-coated stainless steel construction
- UV-Resistant
- Anti-pinch linkage system
- Battery powered 24 volt system
- UPS Packaging for easy shipping
- Includes: Arm and foot rest, safety belt, battery charging station
- User-friendly controls
- Emergency stop system
- Lifetime Structural Warranty
- ADA Compliant

Item #	Description	Weight Capacity	Price
81-625	P-375 Lift no Anchor	375 lbs	\$3950.73
81-626	P-375 Lift w/ Anchor	375 lbs	\$4142.75



81-628

SUPERIOR AQUATIC LIFT

- Powder-coated stainless steel construction
- UV-Resistant
- Anti-pinch linkage system
- Battery powered 24 volt system
- UPS Packaging for easy shipping
- Includes: Arm and foot rest, safety belt, battery charging station
- User-friendly controls
- 5-Year Structural Warranty
- ADA Compliant

Item #	Description	Weight Capacity	Price
81-628	S-350 Lift no Anchor	375 lbs	\$4044.39
81-629	S-350 Lift w/ Anchor	375 lbs	\$3950.73



EXOTUBE® RESCUE TUBE

- Rugged mesh surface increases tube life expectancy
- Includes 2" adjustable tow strap
- Limited Three Year Warranty

Item #	Description	Size	Price
42-032	ExoTube®	50"	\$64.99
42-022	ExoTube®	40"	\$63.99



CJ 1000 SPINE BOARD

- Laminated wood spine board w/ Teflon runners
- Package includes: spine board, "L" bracket head immobilizer, and Velcro body strap
- 500 lb. weight capacity

Item #	Description	Price
47-015	CJ 1000 Spine Board	\$525.00
47-016	CJ 1000 Spine Board Cover	\$19.25
47-065	CJ Head Immobilizer	\$86.50



CJ RESCUE 6 SPINE BOARD

- X-Ray and MRI translucent HDPE spine board
- Adjustable buoyancy
- Package includes: spine board, body straps, head immobilizers, and 2 flotation rods (installed)
- 500 lb. weight capacity

Item #	Description	Price
47-020	CJ Rescue 6 Spine Board	\$405.50



KEMP HEAD IMMOBILIZERS

- Universal attachment base with Velcro head/chin straps
- Colors: red, orange, yellow, royal blue, or black

Item #	Description	Price
47-055	Kemp Head Immobilizer (select color)	\$82.50



LIFEGUARD FANNY PACK WITH STRAPS

- Two straps for water bottle

Item #	Description	Price
42-044	Lifeguard Fanny Pack w/ Straps (red only)	\$7.95



LIFEGUARD FANNY PACKS

- Colors: red, navy, royal blue, and black

Item #	Description	Price
42-046	Lifeguard Fanny Pack (select color)	\$7.50



LIFEGUARD FIRST RESPONDER KIT

- Includes: CPR mask, foil blanket, whistle, break-away lanyard, and safety gloves
- Colors: black, navy blue, red, or royal blue

Item #	Description	Price
42-057	Lifeguard First Responder Kit (select color)	\$18.75



NYLON SWIM VESTS

- Type III Swim Vest includes adjustable chest straps with buckle
- Infant and child versions include adjustable leg strap for added safety
- Colors: red or blue

Item #	Description	Size	Price
44-016	Safety Vest	Adult (90+ lbs)	\$19.25
44-017	Safety Vest	Youth (50-90 lbs)	\$19.25
44-018	Safety Vest	Child (30-50 lbs)	\$19.25
44-003	Safety Vest	Infant/Child (<50 lbs)	\$19.25



NYLON LIFE JACKETS

- Type II Life Jackets with adjustable belt
- Color: orange

Item #	Description	Size	Price
44-005	Life Jacket	Adult (90+ lbs)	\$12.75
44-010	Life Jacket	Youth (50-90 lbs)	\$12.75
44-015	Life Jacket	Child (30-50 lbs)	\$12.75



RING BUOYS

- US Coast Guard Approved
- Color: white

Item #	Description	Size	Price
44-070	Ring Buoy	20" Dia.	\$95.80
44-075	Ring Buoy	24" Dia.	\$109.95
44-080	Ring Buoy	30" Dia.	\$109.95



POOLSTYLE PROFESSIONAL LEAF RAKE

- Heavy-duty frame
- Aluminum handle
- 20" wide & 18" deep
- Replaceable rim & net

Item #	Description	Price
31-115	Standard Mesh Leaf Rake	\$35.95
31-120	Fine Mesh Leaf Rake	\$39.25

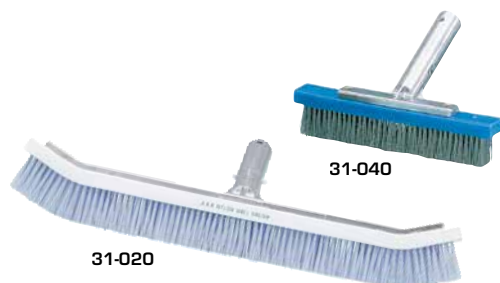

COMMERCIAL POOL BRUSHES

Item #	Description	Size	Price
31-020	Curved Pool Brush	18"	\$25.50
31-025	Curved Pool Brush	24"	\$42.25
31-030	Curved Pool Brush	36"	\$64.50
31-035	S/S Algae Brush	5"	\$17.25
31-040	S/S Algae Brush	9"	\$27.25
31-045	S/S Algae Brush	18"	\$46.53



COMMERCIAL VACUUM HOSE

- Commercial grade floating hose
- Flexible hose that is UV-resistant

Item #	Hose Length	Diameter	Price
29-250	35'	1½"	\$88.50
29-255	50'	1½"	\$106.67
29-270	50'	2"	\$156.00
29-260	75'	1½"	\$142.50
29-275	75'	2"	\$224.00
29-265	100'	1½"	\$184.00
29-280	100'	2"	\$349.50



POOLSTYLE LEAF EATER

- Includes: metal swivel handle and extra tall fine mesh bag

Item #	Description	Price
29-025	Leaf Eater Hose Attachment	\$69.50

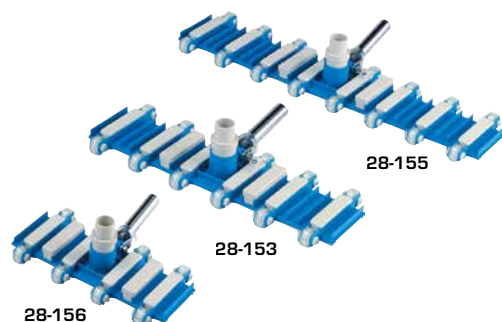

PROVAC COMMERCIAL VACUUM HEADS

- Unique suction chamber concentrates vacuum velocity equally
- Full width flex strips guide debris into the suction chamber
- All wheels are adjustable to increase or decrease the vacuum velocity
- Includes ½ in. vac hose swivel connection (2 in. connection fits directly on vac head)

Item #	Description	Price
28-156	ProVac Flexible Vac Head, 14"	\$116.30
28-153	ProVac Flexible Vac Head, 22"	\$145.50
28-155	ProVac Flexible Vac Head, 29"	\$179.50



COMMERCIAL TELESCOPIC CARBON FIBER HYPERPOLE

- 3K carbon fiber weave construction
- High-strength and lightweight
- Unique stainless steel Hyper Drain/Fill system
- 100% re-buildable

Item #	Extended Length	Collapsed Length	Price
30-056	20'	7' 11"	\$299.00
30-059	32' 11"	9' 9"	\$595.00



SPECK PORTABLE VACUUMS

- Stainless steel cartridge filter and portable cart
- Speck 433-III Pump (1.50 THP)
- 100' Cable (10 AWG wire size)
- In-Line GFCI Installed on cord
- 20A plug installed on end of cord (NEMA 5-20)
- Pump suction: tee w/ ¾" hose bib & swivel
- Includes both 1½" and 2" vac hose adapters
- FREE FREIGHT ON ORDERS OF 4 OR MORE

Item #	Description	Filter Size	Price
27-001	1½ HP Portable Vac	105 ft²	\$3299.00
27-002	1½ HP Portable Vac	155 ft²	\$3599.00



CYCLONE PORTABLE VACUUM

- Multi-Cyclone debris separator extends filter runs
- 75 ft² cartridge filter on powder-coated steel cart
- 110 volt with GFCI and 50' cord

Item #	Description	Filter Size	Price
27-005	1 HP Portable Vac	75 ft²	\$2525.00



NEW! PRECISION V10 HANDHELD VACUUM

- Lithium-ion powered hand-held vacuum
- Can be used by hand or attached to pole
- Sealed battery - up to 120 minutes per charge
- One-piece design, no assembly or maintenance
- Each unit includes: gunite and vinyl vac heads, car and wall chargers, shallow water adapter and filter bags (3)

Item #	Description	Price
29-003	Precision V10 Handheld Vac	\$812.50



26-235

DOLPHIN WAVE 140 VACUUM

- Designed for larger commercial pools
- New top load filter cartridge design
- Dual scrubbing brushes remove dirt and debris
- Includes remote control and caddy cart

Features	Wave 140
Item	26-235
Filter Description	Top-Load Cartridge
Filter Porosity	Fine (100 microns)
Pool Size	Up to 122 ft.
Cleaning Coverage	Floor Only
Cleaning Mode(s)	Quick, Standard, Enhanced
Cleaning Cycle(s)	4, 5, or 6 hours
Scanning	Maze
Suction Rate	8,454 gph
Cable Length	137'
Remote	Included
Vacuum Width	24"
Full Cartridge Indicator	Yes
Weight (without cable)	55 lbs.
Caddy	Included
Warranty	3 Year
Price	\$6999.00

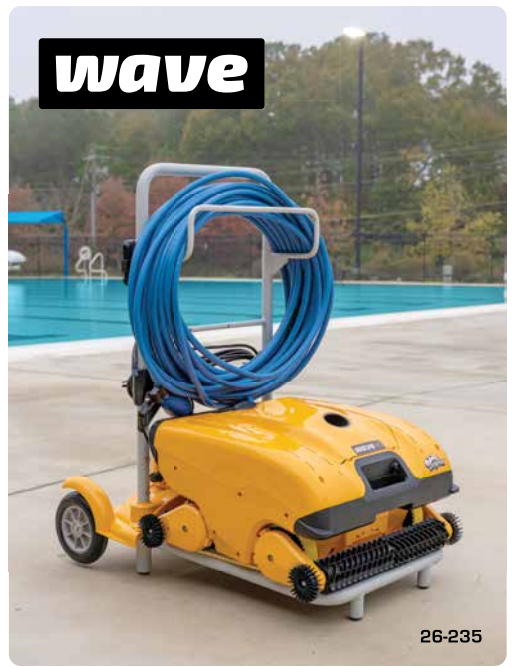

26-235



26-234



26-233



26-232



26-231

Features	Wave 120	Wave 100	Wave 80	Wave 60
Item	26-234	26-233	26-232	26-231
Vacuum Width	30"	16"	16"	16"
Cleaning Cycle(s)	4, 6, or 8 hours	4, 6, or 8 hours	1.5, 2.5, 3.5 hours	1.5, 2.5, 3.5 hours
Cable Length	131'	98'	78'	60'
Remote	Included	Included	Included	Remote-ready (not included)
Caddy	Included	Included	Included	Included
Warranty	2 Year	2 Year	2 Year	2 Year
Price	6499.00	\$3999.00	\$2399.00	\$1699.00

NEW! DOLPHIN WAVE 90i VACUUM

- Designed for larger commercial pools
- New top load filter cartridge design
- Dual scrubbing brushes remove dirt and debris
- Includes remote control and caddy cart



26-255

Features	Wave 90i
Item	26-255
Filter Description	Top-Load Basket
Pool Size	Up to 68'
Cleaning Coverage	Floor, Walls
Cleaning Cycle(s)	2, 3, or 4 hours
Scanning	Scanning w/ Maze
Cable Length	78'
Remote	Wi-Fi
Caddy	Included
Warranty	2 Year
Price	\$3299.00



26-255



INFLATABLE STRUCTURES

- Commercial-grade PVC material with welded seams
- Structures can be used individually or connected together
- Scan the QR code above for all available options

Item #	Description	Length	Width	Height	Min. Water Depth	Max. Capacity	Price
66-255	FoxTrot	240"	78"	19"	48"	6	\$1599.00
66-265	Zulu Slide	135"	78"	60"	68"	1	\$2099.00
66-260	SwimStep XL	60"	78"	6"	48"	2	\$749.99



63-370



63-085



63-090

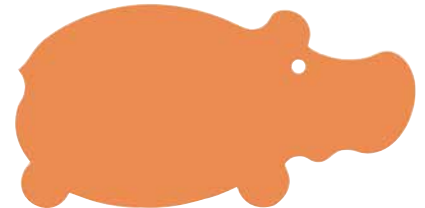

63-100

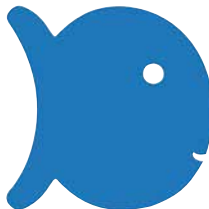

63-095



63-096

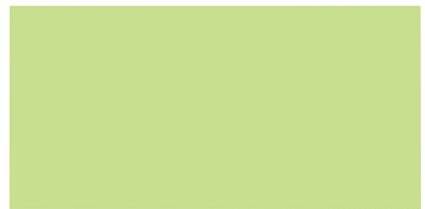

63-105

SWIM N' DUNK WATER BASKETBALL

- Competitive acrylic backboard w/ regulation rim
- Install in water depths less than 42"
- Rock Solid Single Post - includes single post anchor and escutcheon
- Includes SealedSteel protective vinyl coating on frame to prevent corrosion
- Custom heights also available

Item #	Description	Price
63-370	Rock Solid Single Post Goal	\$2659.80

AQUAFUN FOAM MATS & TOYS
BY NORDESCO

- 1½" closed cell, high-density foam mats
- Inquire for available colors

Item #	Raft Style	Size	Price
63-085	Duck	36" x 36"	\$97.50
63-090	Turtle	36" x 36"	\$97.50
63-095	Fish	36" x 36"	\$97.50
63-096	Sailboat	36" x 36"	\$97.50
63-100	Hippo	36" x 72"	\$185.00
63-105	Rectangle	36" x 72"	\$185.00



63-090



**1848 ARNOLD INDUSTRIAL PLACE
CONCORD, CALIFORNIA 94520**

CHANGE SERVICE REQUESTED

MKG-88-029



72-100

SUITMATE WATER EXTRACTOR

- Wall mounted swimsuit dryer removes 95% of suit water in just 8 seconds
- Stainless steel and high-impact plastic construction
- Inquire about custom wraps

Item #	Description	Price
72-100	Suitmate Water Extractor	\$2175.00



38-059

38-057

38-058

CHAMPION GUARD CHAIRS

- Recycled plastic material
- Includes: contoured back, umbrella holder, and cup holder
- Colors: white, green, sand, or cedar

Item #	Seat Height	Overall Height	Price
38-057	30"	51"	\$728.25
38-058	40"	61"	\$1063.75
38-059	50"	70"	\$1205.00



73-127

HERONRIB MATTING

- Flexible flooring rolls can be cut to fit any application
- Optional vinyl edging strips for edge ramping, joining strips link material lengths together, and side-to-side clips join rolls together
- Colors: oxford blue, ocean blue, charcoal gray, forest green, mulberry red, white, or buff

Item #	Description	Size	Price
73-126	Heronrib Matting	2' x 33'	\$659.20
73-127	Heronrib Matting	3' x 33'	\$968.50
73-128	Heronrib Matting	4' x 33'	\$1249.00